

# SF000/B microLiDAR® sensor

**The world's smallest and lightest  
50-meter microLiDAR® sensor.**



## Disclaimer

*Information found in this document is used entirely at the reader's own risk and whilst every effort has been made to ensure its validity, neither LightWare Optoelectronics (Pty) Ltd, its subsidiaries, nor its representatives make any warranties with respect to the accuracy of the information contained herein.*



FM 654831



## Welcome to LightWare

Thank you for selecting LightWare as your **partner** in microLiDAR® distance sensing technology.

LightWare is a pioneer in microLiDAR® distance sensors, drawing upon **four decades** of expertise in LiDAR technology to develop application-specific products renowned for their **accuracy, reliability, and durability**. LightWare's assembly process involves meticulous handling of sensors and optics, creating microLiDAR® sensors of world class quality. Our production methods benchmark the **ISO 9001:2015** standards at scale, with manufacturing capabilities reaching up to **45,000 units annually**, with each microLiDAR® unit crafted to the same exacting standards. Unsurprisingly, leading companies worldwide trust LightWare as their **preferred LiDAR partner**.

We are dedicated to ensuring **your success** when using LightWare microLiDAR® sensors to address your unique distance measuring and geospatial challenges.

Beyond this comprehensive product guide, our website's **resource center** (<https://lightwarelidar.com/>) offers a wealth of supplementary information, **including APIs, CAD drawings, and FAQs**.

Our dedicated technical support desk is at your service if you require assistance with integration or technical queries. Reach out to them at [support@lightwarelidar.com](mailto:support@lightwarelidar.com).

LightWare products come with a **24-month limited warranty**, covering any defects in material or workmanship under normal use. For detailed warranty information, please refer to our website at <https://lightwarelidar.com/terms-and-conditions/>. We're here to support you on your journey — sensing your world with LightWare LiDAR.



# Table of contents

1	Overview .....	5
2	Safety .....	6
2.1	Laser eye safety.....	6
2.2	Labeling .....	7
2.3	Laser radiation information.....	7
3	Key technical specifications .....	8
4	Accessories .....	9
4.1	USB adapter.....	9
4.2	Communications cable.....	9
4.3	Pixhawk adapter.....	10
4.4	Breakout board .....	10
4.5	DroneCAN adapter.....	11
5	Getting started.....	12
6	Parameters, filters, settings and tools.....	17
6.1	Setting the device parameters .....	17
6.2	Filters .....	18
6.3	Settings and tools.....	20
7	Installation, mounting and cabling .....	21
7.1	Mechanical interface.....	21
7.2	Mounting bracket.....	22
7.3	Mounting and alignment instructions .....	22
7.4	Orientation.....	24
7.5	Communication and power cable.....	25
8	Advanced features .....	25
8.1	First and last pulse detection.....	25



8.2	Servo Drivers .....	27
9	Communication interfaces.....	28
9.1	Serial UART interface .....	28
9.2	I <sup>2</sup> C interface .....	29
10	Commands.....	29
10.1	Command structure .....	30
10.2	Checksum algorithm.....	31
10.3	Reading bytes .....	32
10.4	Sending commands .....	33
10.5	Saving .....	33
10.6	Command list .....	34
11	Firmware updates .....	37
12	Troubleshooting.....	38
13	Repair and maintenance .....	39
13.1	Maintenance and calibration.....	39
13.2	Cleaning.....	39
13.3	Electrical safety.....	39
13.4	Service and repairs .....	40
14	End-of-life safe disposal .....	41
15	Document revision history.....	42



# 1 Overview

This product guide is a comprehensive companion to your LightWare SF000/B microLiDAR®, a groundbreaking **50-meter sensor** renowned as the **world's smallest and lightest** in its category, meticulously engineered **for size- and weight-constrained applications**.

LightWare's SF000/B is a **compact, ultralight, and energy-efficient sensor** that utilizes the *time-of-flight* principle to measure distance by emitting a rapid succession of laser pulses that are reflected by target objects and received back and immediately processed. It uses 905-nanometer laser technology, ensuring optimal performance at an affordable price, while meeting **class 1M eye safety** standards. The SF000/B's accuracy is not affected by the color or texture of the target or object surface or the laser beam's angle of incidence. It is virtually **immune to background light, wind, and noise**, rendering it an ideal sensor for outdoor use.

Configurable features and versatile hardware interfaces make the SF000/B **easily compatible** with **various controllers**. The SF000/B is commonly mounted on UAV airframes, facing downward or forward, and its compact design allows multiple sensors to easily fit onto a single UAV, or effortlessly **integrate into the struts of a multicopter**. Supporting **first and last pulse processing**, this microLiDAR® provides critical **height-above-ground** data while simultaneously **detecting potential obstacles** such as tall trees.

Equipped with an onboard servo motor driver, the SF000/B can be used for **2D and 3D LiDAR applications**, offering customizable beam steering to meet specific requirements. Its adaptability makes it an indispensable component for **indoor navigation and surveillance**, particularly in scenarios **where low-altitude drone flight** through obstacle-laden terrain is essential.

With the SF000/B microLiDAR® now part of your toolkit, you have a solution delivering unparalleled precision, adaptability, and reliability across many applications.



Figure 1: Front and side view of the SF000/B



## 2 Safety

Always adhere to these product safety precautions and operate the sensor strictly following the guidelines outlined in this product guide. LightWare bears no responsibility or liability for any damage or injury, whether direct or indirect, arising from a failure to comply with these stipulations. Non-compliance with the precautions or warnings provided in this product guide constitutes a breach of safety standards intended for the proper use of the sensor.

### 2.1 Laser eye safety

LightWare LiDAR sensors comply with the *United States Food and Drug Administration (FDA) laser eye safety regulations* for safe use around humans and animals, based on the international standard IEC/EN 60825-1 and utilizing LaserSafe PC Professional for the computations.

**Caution: The SF000/B contains a laser and should never be aimed at a person or animal. Do not view the laser with magnifying optics such as microscopes or telescopes.**

This laser product emits non-ionizing laser radiation. It is classified as Class 1M, indicating that the laser beam is safe to look at with the naked eye during normal use. However, avoid viewing it through magnifying optics such as binoculars, microscopes, telescopes, etc. Despite the safety rating, refrain from looking into the beam, switch off the device when in the vicinity, and never stare directly into the lens from less than half a meter.

**Caution: Use of controls, adjustments, or performance of procedures other than those specified herein may result in hazardous radiation exposure.**

#### **Warning: Risk of permanent eye damage**

- Class 1M lasers are **unsafe** if viewed through **magnifying optics such as microscopes, binoculars, or telescopes from a distance less than the NOHD.**
- The laser eye safety rating of the LRF depends on the mechanical integrity of the optics and electronics. It must **not be disassembled or modified in any way.**
- **If the LRF sensor is damaged, do not continue using it.**
- The LRF sensor should be mounted using the mounting holes. **Do not attach to or clamp the lens tubes**, which may cause damage and adversely affect the laser safety rating.
- There are **no user-serviceable parts**, and maintenance or repair must only be done by the manufacturer or a qualified service agent.
- No regular maintenance is required, but if the lenses start collecting dust, they may be wiped with suitable lens-cleaning materials. Ensure that the device is switched off before looking into the lenses.



## 2.2 Labeling

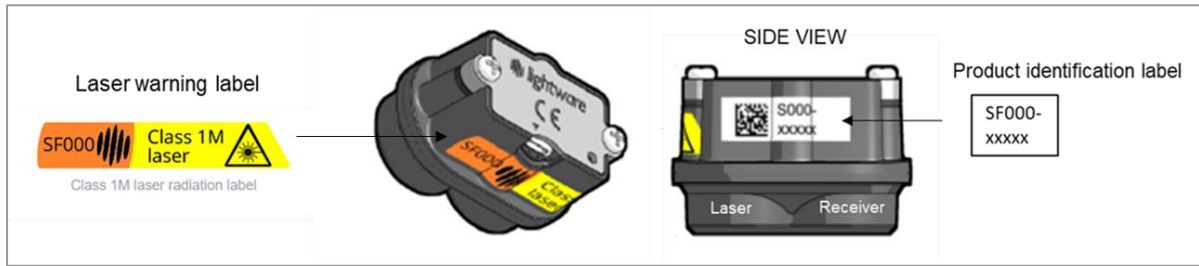

Figure 2: SF000/B laser warning label

**Important note: It is a legal requirement to display the laser warning label on your final product or system.** To assist with this, LightWare has included an extra laser warning label in the packaging.

## 2.3 Laser radiation information

Table 1: Laser radiation information

Specification	Value
LightWare product	SF000/B microLiDAR®
LiDAR type	Static single beam
Eye safety classification	Class 1M
Laser wavelength	905 nm
Pulse width	16 ns
Pulse frequency	20 kHz
Average power	2.5 mW
Average Energy per pulse	198 nJ
Nominal Ocular Hazard Distance (NOHD)*	15 m (50 ft)

\* Distance beyond which binoculars may be safely used.

Approximate values only. Please contact LightWare LiDAR if further information is required.



### 3 Key technical specifications

Table 2: SF000/B microLiDAR® key technical specifications

SF000/B microLiDAR® key technical specifications	
<b>Performance</b>	
Range	0.2 to 50 m / 0.6 to 164 ft (70% albedo in sunlight conditions, 0.9 x 0.9 m target size)
Update rate	48 to 388 readings per second (customizable to suit application)
Resolution	1 cm / 0.4 in
Accuracy	± 5 cm / ± 2 in
<b>Connections</b>	
Power supply voltage	4.5 to 5.5 V
Power supply current	84 mA (typical)
Outputs and interfaces	Serial UART and I <sup>2</sup> C (3.3 V TTL, 5 V tolerant)
<b>Form Factor</b>	
Dimensions	24 mm x 34 mm x 20 mm / 0.9 in x 1.3 in x 0.8 in
Weight	9.81 g / 0.4 oz (excluding cables)
<b>Optical</b>	
Approvals	FDA Accession: 1710193-000 (2020/09) CE certified ROHS3 Compliant REACH unaffected NDAA compliant (Section 848) Blue UAS ready
Laser safety	Class 1M (Please refer to the eye safety section of this user guide, above)
Optical aperture	11 mm / 0.43 in
Beam divergence	< 1°
<b>Environmental</b>	
Operating temperature	-20°C to 60°C / -4°F to 140°F
Shipping temperature	-40 to -80 °C / -40 to -176 °F
Enclosure rating	Unit has no rating (IP00 full unit) Front face is IP65
<b>Accessories</b>	
USB adapter	ACC.USB.000
Communications cable	HPN-3795-1
Pixhawk adapter	ACC_PX_SF000
Breakout board	ACC.BOB.000
DroneCAN Adapter	ACC_DroneCAN
ABS Mounting bracket	LW 000_199
<b>Default settings</b>	
Serial port settings	115200 baud, 8 data bits, 1 stop bit, no parity, no handshaking
I <sup>2</sup> C address	0x66 (Hex), 102 (Dec)
Update rate	48 readings per second



## 4 Accessories

To support configuration and integration, the following SF000/B accessories are available for purchase from the LightWare website:

### 4.1 USB adapter

To configure and test your SF000/B via LightWare Studio, a USB adapter will be needed:



Figure 3: ACC.USB.000 USB adapter for SF000/B

### 4.2 Communications cable

Each SF000/B is supplied with a communication and power cable. Additional cables are available for purchase from our online store.



Figure 4: HPN-3795-1 Communications cable for SF000/B



## 4.3 Pixhawk adapter

The optional 5-way Pixhawk adapter provides a convenient plug-and-play link between the SF20/C and Pixhawk-class flight controllers.

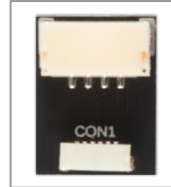

Figure 5: ACC\_PX\_SF000 Pixhawk adapter for SF000/B

## 4.4 Breakout board

An optional breakout board accessory is available to facilitate the integration of the SF000/B into a host controller such as a Pixhawk, PX4, Raspberry Pi, or Arduino. It consists of five reusable adapter boards to conveniently connect the SF000/B communication cable to other standard cables and host controllers, without requiring soldering.

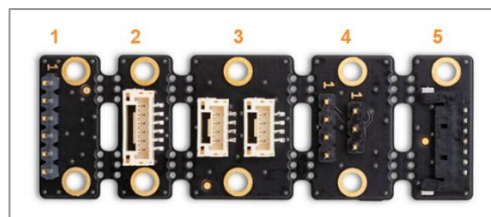

Figure 6: ACC.BOB.000 breakout board for SF000/B

Table 3: Breakout board sub-boards

<b>Board 1</b>	Six-pin header connector	Six pins corresponding to the SF000/B communication cable pins. Pin 1 is labeled on the board.
<b>Board 2</b>	Six-way serial interface connector	Ideal for use on the telemetry <i>telem</i> port of the Pixhawk.
<b>Board 3</b>	Four-way I <sup>2</sup> C interface connector	Use an I <sup>2</sup> C cable to connect the board to the I2C port of the Pixhawk. Twin connections allow a daisy chain connection to other sensors.
<b>Board 4</b>	Servo motor interface connector	The host controller can power, communicate with, and control both the servo motor and the SF000/B through this board, using serial communication.
<b>Board 5</b>	Seven-way serial connector	For the SF11 and SF30 communications cable (LW 000_135) to enable easy replacement.



## 4.5 DroneCAN adapter

A DroneCAN adapter is available to seamlessly integrate the LightWare LiDAR rangefinder with DroneCAN enabled flight controllers.

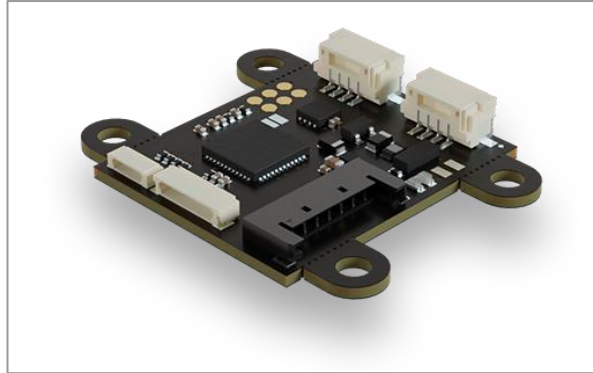

Figure 7: ACC\_DroneCAN – DroneCAN adapter



## 5 Getting started

LightWare Studio is a free application (available for Windows, macOS, and Linux) and is the gateway to configuring your microLiDAR® sensor and visualizing your data. This software empowers you to customize settings, fine-tune sensor parameters, and easily analyze data. It also facilitates firmware upgrades and in-field diagnostics and support.

Detailed step-by-step videos are available on LightWare's YouTube channel:

<https://www.youtube.com/@LightWareLiDAR/videos>

Follow these easy steps to get going with your LightWare microLiDAR®:

1. Download and install the version of LightWare Studio compatible with your operating system from the Resource section of LightWare's website at <https://lightwarelidar.com/>. You can safely install over an existing version of LightWare Studio if you are upgrading.

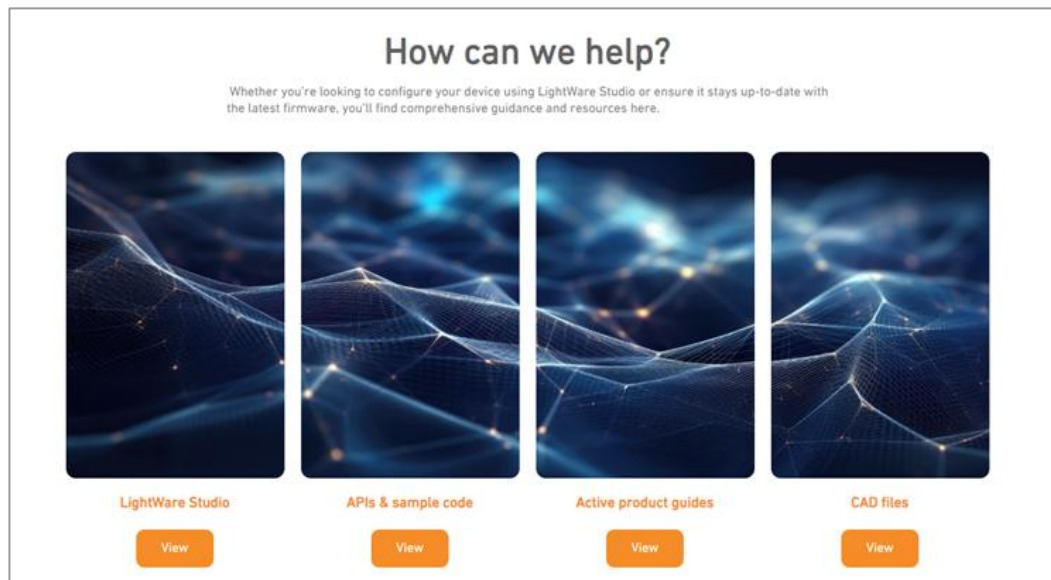

Figure 8: LightWare Studio website download page

2. Once the installation is complete, the *Welcome to LightWare Studio* page will open, prompting you to attach a device to your computer.
3. Carefully insert the supplied connector cable into the designated header on the rear side of the sensor. Confirm that it is oriented correctly, and gently push it in until it securely locks in place.



4. Likewise, insert the opposite end of the connector cable into the corresponding header on the USB adapter. (To unplug these cables, use a small flat-head screwdriver in the groove on the connector.)

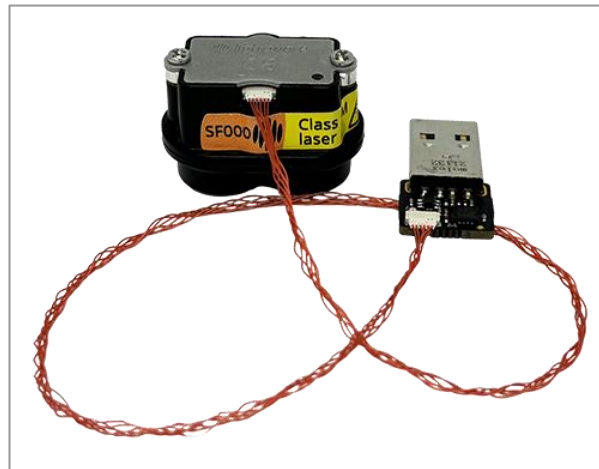

Figure 9: SF000/B connection to a USB adapter

5. Insert the USB adapter into your computer. The red power LEDs on the USB adapter and the back of the sensor will light up. (To disconnect simply pull the USB adapter out of the computer's port.)

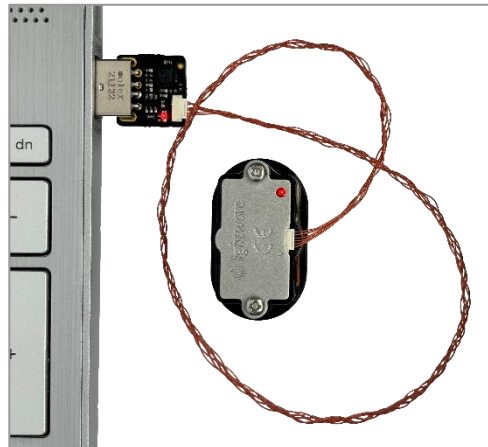

Figure 10: Red power LED on the USB adapter and the SF000/B are both illuminated



6. When connecting the sensor for the first time, Windows users may experience a brief delay as the operating system installs the necessary generic communication driver. Please allow the installation process to complete.
7. LightWare Studio will automatically detect the device and present it for selection on the Welcome page. The Welcome page may show other communications ports on your computer. Select the port that shows the connection to your LightWare sensor.

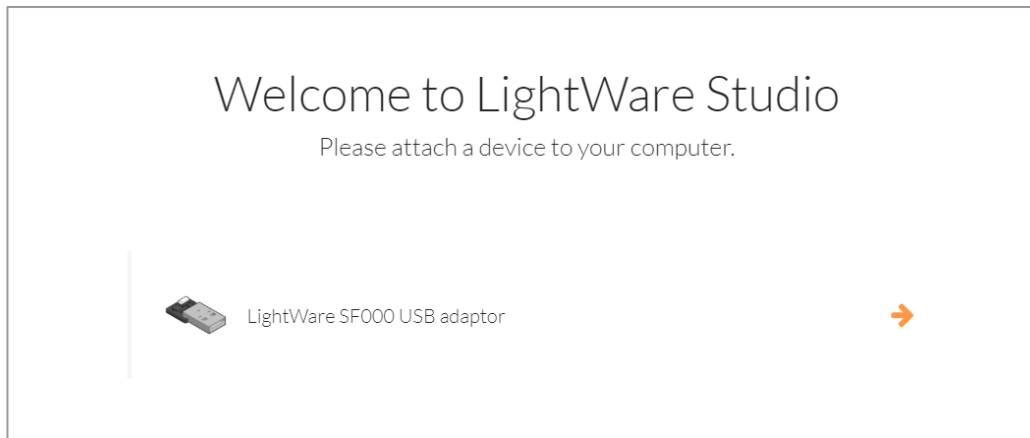

Figure 11: LightWare Studio device connection page

8. LightWare Studio will start on the device's Info page, indicating the serial number, hardware version and firmware version of your device.

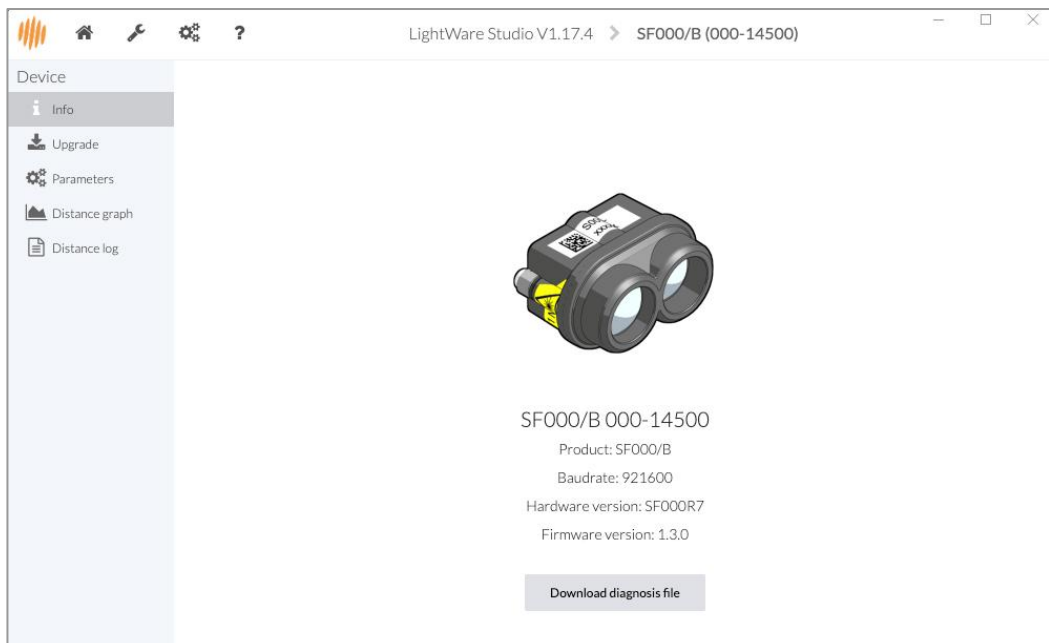

Figure 12: LightWare Studio device information page

**Caution: Always keep your LightWare microLiDAR® sensor's software up to date**



- Select the *Distance graph* tool from the left menu to access real-time measurements from the sensor. Point the sensor at different obstacles to observe instant changes in distance, providing valuable insights into the sensor's live functionality.



Figure 13: LightWare Studio distance graph page

- On this page, you can control specific device parameters, which are also accessible from the dedicated parameters page. (Please refer to the section below for a more comprehensive understanding of these parameters.)

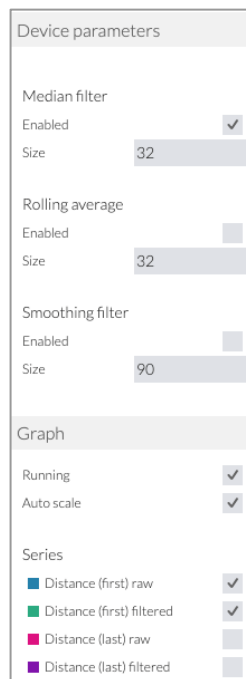

Figure 14: LightWare Studio parameters display page



11. Navigate to the *Distance log* tool from the left panel. This tool streams live distance data in meters as it is scanned by the sensor. Toggle the parameters on the left to stop or start the streaming, add line numbers, or time stamps, or switch on different data types.
12. Data can be downloaded and saved using the *save* icon above the data.

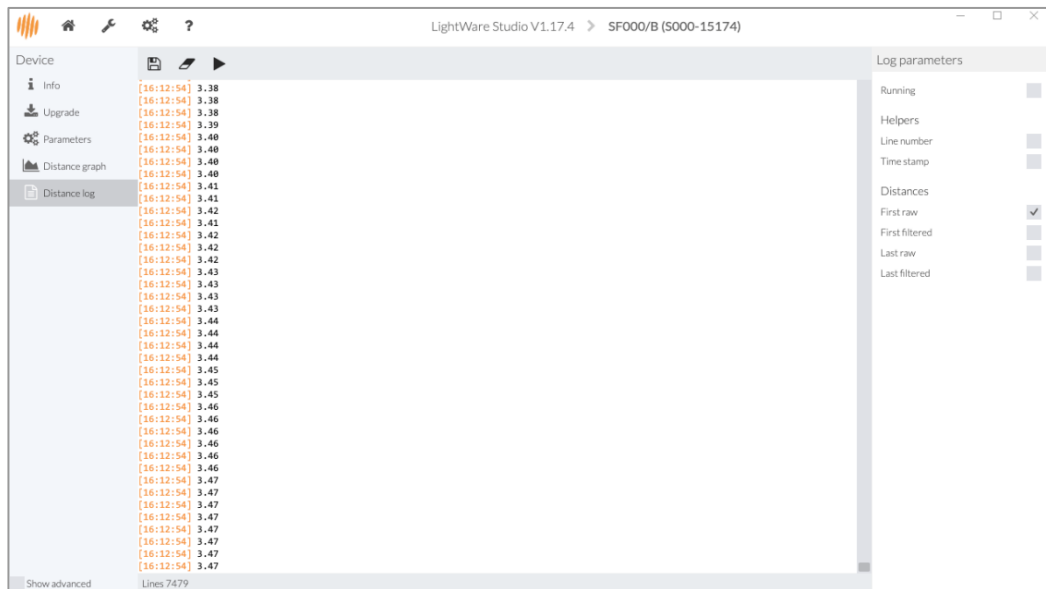

Figure 15: LightWare Studio distance log page showing measurements

### Sensor output

The sensor will stream distance readings with out-of-range conditions reading as -1.00. Signal strength information is available on demand. Refer to the command list in this product guide for more information.



## 6 Parameters, filters, settings and tools

### 6.1 Setting the device parameters

Your LightWare SF000/B microLiDAR® sensor can be configured via LightWare Studio or from a host controller using the product commands through the serial UART or I<sup>2</sup>C communication interfaces.

To set the device parameters using LightWare Studio:

1. In the left panel, click on *Parameters* to open the detailed parameters page.
2. The scroll-down list of adjustable parameters will be displayed, with explanatory notes and dropdown options.

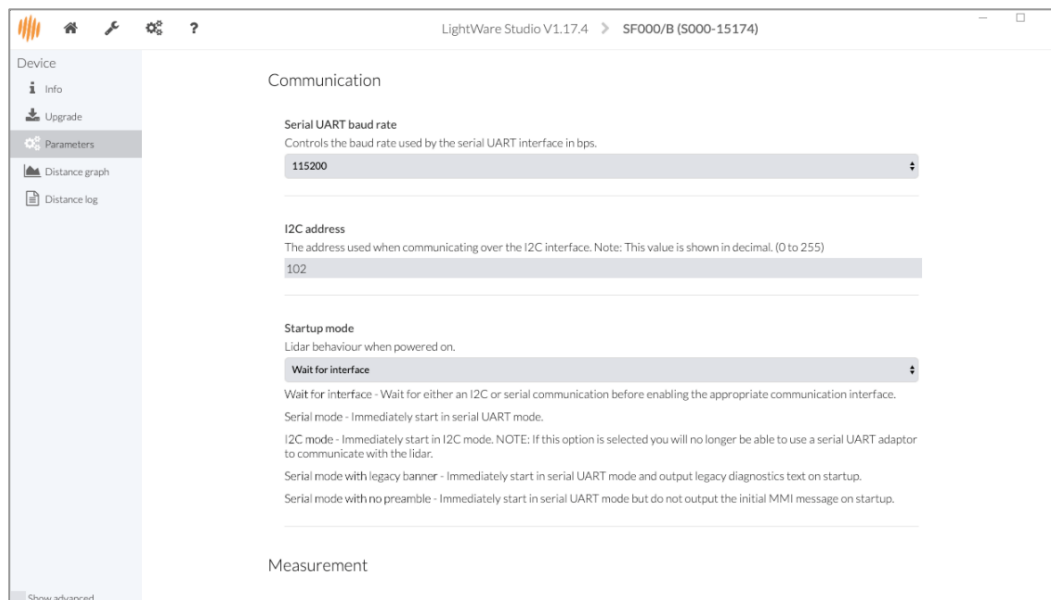

Figure 16: LightWare Studio detailed parameters page

3. Set your device parameters according to your requirements. Refer to the table below for more information.



Table 4: SF000/B Adjustable Parameters

Parameter	Explanation	Options
<b>Communication</b>		
Serial UART baud rate	Select the serial UART interface baud rate, (in bps).	From 9600 to 921,600
I2C address	The address used when communicating over the I <sup>2</sup> C interface. A whole number in decimal.	From 0 to 255
Startup mode	Select the communication behavior when powered on <b>Wait for interface:</b> Wait for either an I <sup>2</sup> C or serial [UART] communication before enabling the appropriate interface. <b>Serial mode:</b> Immediately start in serial UART mode. <b>I2C mode:</b> Immediately start in I <sup>2</sup> C mode. Note: If this option is selected, you will no longer be able to use a serial UART adapter to communicate with the sensor. <b>Serial mode with legacy banner:</b> Immediately start in serial UART mode and output legacy diagnostics text on startup. <b>Serial mode with no preamble:</b> Immediately start in serial UART mode, but do not output the initial MMI message on startup.	Wait for interface; Serial mode; I <sup>2</sup> C mode; Serial mode with legacy banner; or Serial mode with no preamble
<b>Measurement:</b>		
Update rate	Select the number of measurements taken per second (Hz).	From 48 to 388
Zero distance offset	The offset applied to the measured distance value. (In meters, up to three decimal places.)	-10 to 10
Lost signal threshold	The number of failed readings required before a loss of signal is reported, (whole number).	1 to 250
<b>Filtering:</b>		
Median filter enabled	Used to disregard short unwanted readings.	Select or de-select the checkbox.
Median filter size	The response time of the median filter. (Whole number, in seconds.)	3 to 32
Rolling average enabled	Used to average out a specified number of last-distance results.	Select or de-select the checkbox.
Rolling average filter size	The number of distance results to use for the rolling average filter, (whole number).	2 to 32
Smoothing filter enabled	Used to remove noise from the measurements.	Select or de-select the checkbox.
Smoothing filter strength	The stronger the smoothing, the slower the response to change, (whole number).	0 to 100
<b>Extra</b>		
LED enabled	Turns the device LED on or off.	Select or de-select the checkbox.

## 6.2 Filters

### Median Filter



This is a non-linear filter in which each output is the median, or middle, of the readings in the filter window. It is helpful for removing outliers and signal noise. A typical application is flying over terrain where quick changes in terrain height must not affect the altitude of the UAV, such as over water. The larger the filter size, the more immune the filter is to noise. This, however, does result in a delayed response to changes in the measurement.

### **Rolling average filter**

A rolling average filter averages a fixed number of the newest data points. This smooths out short-term fluctuations and reveals trends. Typically applied when noisy fluctuations should be ignored, but the general profile of the data should be maintained, such as for terrain following.

### **Smoothing filter**

This filter smooths sharp changes in the data while preserving slower changes. It helps to remove noise from the data and slows the response to sudden data changes. Typically used when monitoring the distance to stationary surfaces, such as when taking level measurements and filling rates.



## 6.3 Settings and tools

Additional application **settings** are available by clicking on the *gears* icon in the top menu:

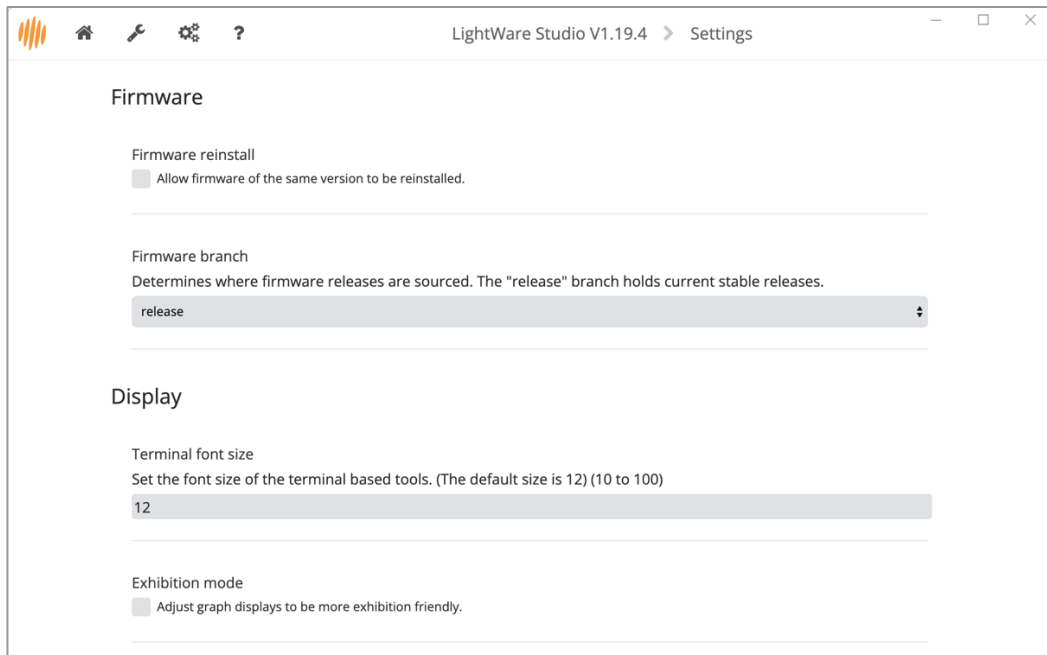

Figure 17: LightWare Studio application settings page

You can also access the **specialized device tools page** by clicking on the *wrench* icon in the top menu, where you can access a traditional terminal if needed:

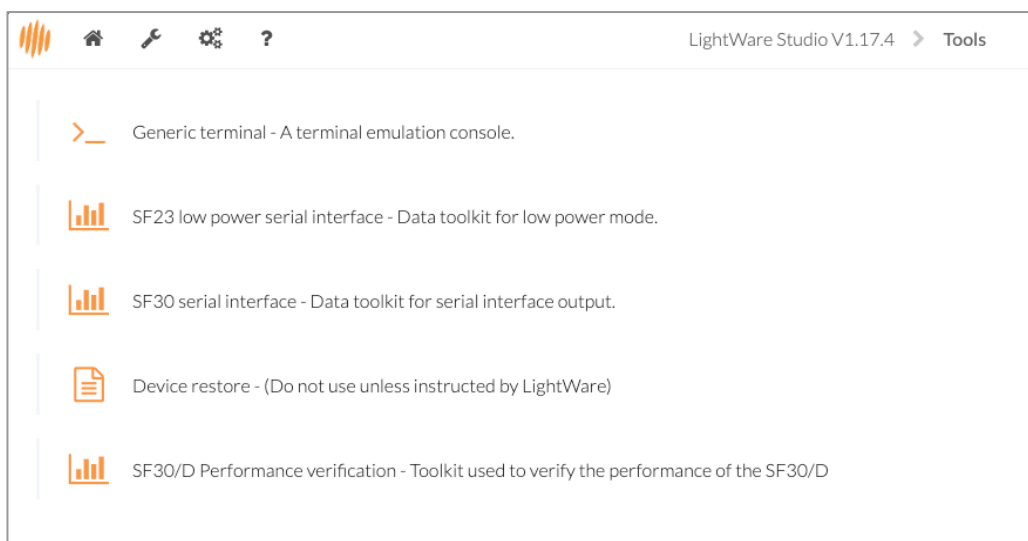

Figure 18: LightWare Studio specialized tools page



# 7 Installation, mounting and cabling

## 7.1 Mechanical interface

For detailed CAD files, please refer to the LightWare Resource Center at <https://lightwarelidar.com/>

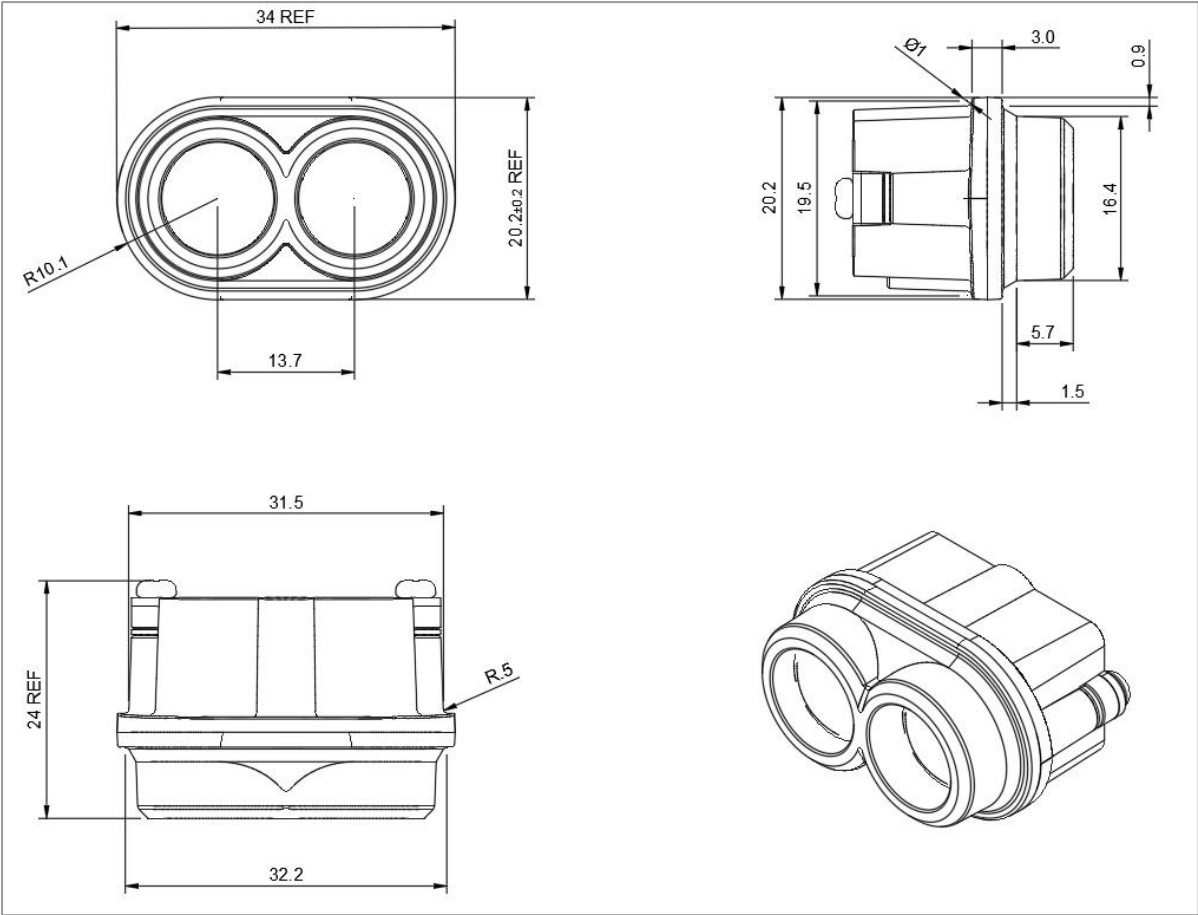

Figure 19: SF000/B mechanical interface



## 7.2 Mounting bracket

An ABS mounting bracket is available from the LightWare web store. Alternatively the CAD file can be downloaded from the LightWare Resource Center at <https://lightwarelidar.com/> to print your own bracket. The mounting bracket is used to secure the SF000/B to any flat surface.



Figure 20: LW 000\_199 Mounting bracket for the SF000/B

## 7.3 Mounting and alignment instructions

Take careful note of the following points when mounting the sensor:

- When choosing a position, ensure that there is **nothing in the path** of the laser beam, and **no shiny or highly reflective surfaces near the beam path**, that could result in false signals.
- Do not mount the sensor within the cavity of the airframe. This can cause false readings in short-range distances (side lobes) or out-of-range conditions. Mount the sensor **flush with the exterior** or keep the recess conical and shallow.
- Ensure a **watertight seal** between the front flange and surface to protect the back end of the sensor.



Figure 21: An example of good integration



- Make sure the sensor is securely mounted to prevent false readings or damage.
- LightWare microLiDAR® sensor are designed for installation with exposed lenses. If it is to be mounted behind glass, ensure non-reflective glass is used to prevent false readings. The glass must have good transmission at 905 nm wavelength, with an anti-reflective coating optimized for this wavelength.
- The back shield reduces electromagnetic interference (EMI), preventing the sensor and other nearby electronic items from interfering with each other. It also acts as a heatsink to help cool the device.
- Ensure that adequate ventilation or heat sinking is provided if the sensor is incorporated into a custom enclosure, as heat build-up could occur.

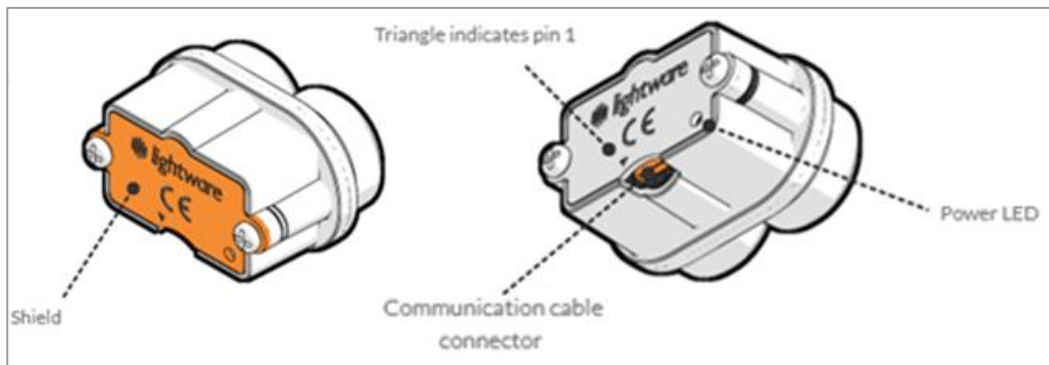

Figure 22: SF000/B shield, connectors & indicators

- Secure the communication cable to prevent it from pulling on the connector port.



## 7.4 Orientation

The sensor requires a clear line-of-sight to measure distance to a target surface. It can be mounted with a vertical or horizontal lens orientation.



Figure 23: Sensor mounting orientations

It can be mounted in a downward-facing, angled, or forward-facing orientation, depending on your application:

- Mount with a downward-facing orientation for altimetry, terrain following, or precision landing applications.
- Mount at an angle to reduce reaction lag time for terrain following. The ideal angle depends on the speed traveled and the overall system lag, but should be between  $20^\circ$  and  $45^\circ$ .
- Mount in a forward-facing orientation for sense-and-avoid or position-hold applications.

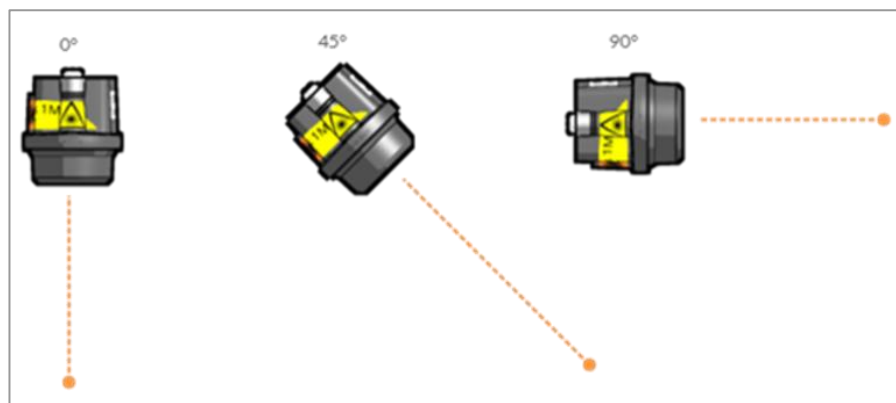

Figure 24: Sensor mounting angle



## 7.5 Communication and power cable

The sensor is supplied with a communication cable. Spare cables are available from the LightWare online store: <https://lightwarelidar.com/>

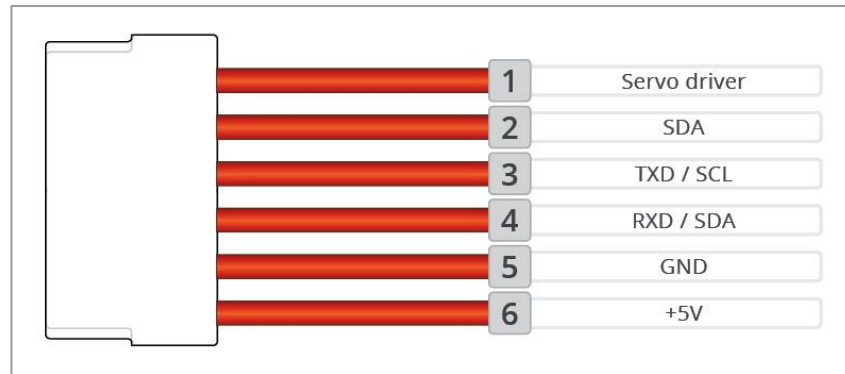

Figure 25: Communication cable (HPN-3795-1) pinout

Table 5: SF000/B pinout table

Pin	Serial Function	I <sup>2</sup> C Function
1	Servo driver — Servo 1 control output (3.3 V)	
2	[not used]	SDA — I <sup>2</sup> C serial data line (used with pin 4)
3	TXD — serial data transmitted	SCL — I <sup>2</sup> C serial clock line
4	RXD — serial data received	SDA — I <sup>2</sup> C serial data line (used with pin 2)
5	GND — power supply negative	[not used]
6	+5 V power supply positive (4.5 V to 5.5 V, 100 mA typical)	

**Important note:** when connecting to the device using I<sup>2</sup>C, both pins 2 and 4 must be used together as the SDA line.

## 8 Advanced features

### 8.1 First and last pulse detection

This LightWare microLiDAR® sensor features first and last pulse processing, capturing both initial and final laser return signals in scenarios where multiple objects are within the sensor's line of sight. It is important to note that objects must be separated by approximately five meters or more for separate return signals to be recognized.



First and last pulse capability allows the microLiDAR® sensor to measure its altitude above the ground while simultaneously monitoring its height above treetops or structures for collision avoidance, and enhances performance in challenging environmental conditions like dust, rain, fog, and snow. By discerning both pulses, the sensor can effectively penetrate these elements and accurately report the furthest distance as the actual target. This feature also allows the sensor to measure the distance to objects through foliage.

A glass window in the sensor's line of sight will reflect some laser energy back toward the receiver, potentially resulting in false readings. The sensor's first and last pulse detection feature can usually mitigate this issue, depending on the type of glass used.

Although first and last pulse detection is helpful when the sensor needs to be positioned behind a protective window, this type of mounting is not recommended, as LightWare sensors are designed to be integrated with exposed lens elements.

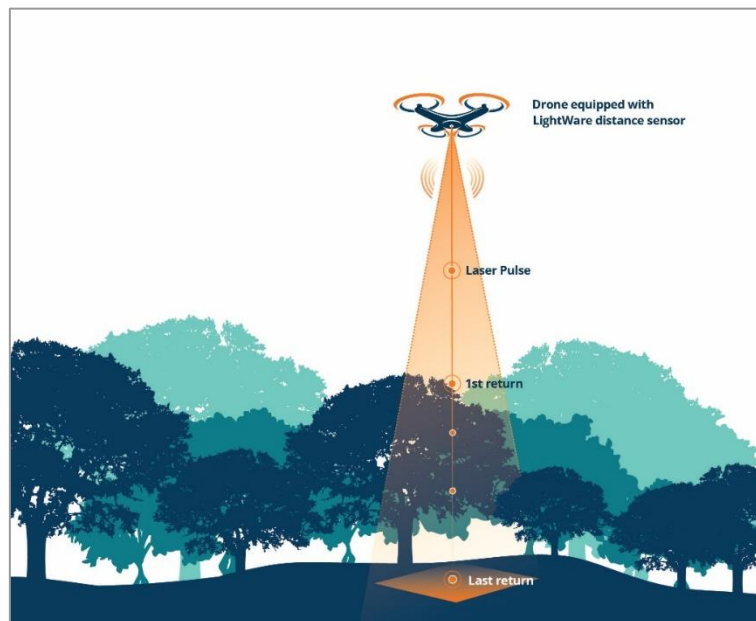

Figure 26: First and last pulse detection



## 8.2 Servo Drivers

The SF000/B microLiDAR® sensor is equipped with an onboard servo driver and can easily be paired with a digital servo motor using the onboard servo driver hardware and software to create a 2D or 3D scanning LiDAR. The sensor can then be aimed in selected directions or used for autonomous scanning. With live-streamed data, this creates an effective SLAM (simultaneous localization and mapping) device and collision sensor by activating the two internal collision avoidance warning alarms in real time. Standard digital servo motors are recommended, as the control signal response for analog servo motors is too slow

Connect the microLiDAR® sensor and servomotor sharing a common ground connection. To reduce the risk of power supply spikes influencing the sensor's performance, it is crucial to run the servo from a separate power supply. Check the servo specifications for the correct voltage and current ratings and ensure a common connection to the negative rails of the sensor and servo power supplies. Most standard digital servomotors are compatible, but analog servomotors are not compatible due to their slow control signal response.

Refer to the LightWare website FAQs <https://lightwarelidar.com/resources-faqs/> for more information on setting parameters for the servomotor sweep limits and speed, servo lag, field of view, and scan type.



## 9 Communication interfaces

The LightWare microLiDAR® sensor can be connected to a host controller, transmitting results and receiving commands with a serial UART or an I<sup>2</sup>C communication interface.

- The one-to-one serial UART interface allows one sensor to communicate with a single host controller.
- The configurable address of the I<sup>2</sup>C communication interface allows multiple sensors to be connected to one host controller on a common bus.

Once a sensor is connected to a host controller, the first command from the host controller will inform it which of the two communication interfaces is being used. Subsequent commands sent from the host controller to the sensor will request values, change settings, or alter the sensor's performance. The sensor will reply to a single command with a single reply, although the streaming command allows the sensor to continuously update the reply without the host resending the command. Note that streaming data is only available through the serial UART interface. The complete command list is contained in this product guide.

We suggest using LightWare's pre-built APIs wherever possible, which are available via the LightWare website resource center. If you require more control or do not find a suitable pre-built API, you can use the information below to build a compatible system. The packet-based binary protocol is compatible with higher-level APIs like C, Python, and JavaScript. Please contact LightWare for assistance with APIs or programming if required.

### 9.1 Serial UART interface

For serial UART communication, the sensor uses encapsulated packets to send and receive data. A packet sent **to** the sensor is a request. A correctly formatted request will always be **replied** to with a response. Streaming is available through the serial UART interface. In this case, the sensor sends request streaming packets without a direct request from the host, and they do not require a response from the host.

Requests are made using one of the sensor commands. The complete command list is contained in this product guide. Commands are flagged as either read or write. When a read request is issued, the response will contain the requested data. When a write request is issued, the contents of the response will vary depending on the command.



Default serial UART interface properties:

- Baud rate: 115200 (configurable)
- Data: 8 bit
- Parity: none
- Stop: 1 bit
- Flow control: none

## 9.2 I<sup>2</sup>C interface

For I<sup>2</sup>C communication, the sensor will always be the slave on the I<sup>2</sup>C interface and only transmit data when requested by the master.

Multiple sensors can be connected to an I<sup>2</sup>C bus. The I<sup>2</sup>C serial bus configurable address allows connecting multiple devices on a common bus. Default I<sup>2</sup>C interface Address: 0x66 or 102. The sensor's I<sup>2</sup>C interface SDA and SCL pins use 3.3 V logic levels with a 3.3kΩ pull-up resistors, but are also 5 V tolerant.

Requests are made using one of the sensor commands. The complete command list is contained below in this product guide. When a read request is issued the response will contain the requested data. When a write request is issued there is no response generated.

## 10 Commands

Your LightWare microLiDAR® uses the packet-based binary protocol for both serial UART and I<sup>2</sup>C communication. The packet-based binary protocol is a register-based protocol that is compatible with higher-level APIs like C, Python, and JavaScript. This protocol allows for various data streaming from a single request.

The first command sent by the host to the sensor after powerup will be used to detect whether serial UART or I<sup>2</sup>C mode is in use. The sensor will not return a response to the first command. Subsequently, for each command sent by the host controller, a single reply will be returned by the sensor.

To initialize the communication with the sensor, send the command to request the Product name. It is advisable to send the command to query the Product name twice in succession shortly after powerup. As described above the first request will not return a response, however the second request will return the product name, indicating that the sensor has indeed initialized successfully, and a handshake has been successfully established with the sensor.



The streaming (\$) command can be used to command the sensor to continuously update the reply without waiting for the host controller to resend the command

## 10.1 Command structure

Both request and response **packets** are composed of the following bytes:

Table 6: Packet composition

	Header			Payload		Checksum	
Byte	start	flags low	flags high	ID	data	CRC low	CRC high

Table 7: Header Flag byte explanation

Byte	Flags high								Flags low							
Bit	15	14	13	12	11	10	9	8	7	6	5	4	3	2	1	0
	Payload length (0 to 1023)								Reserved					Write		

- The **start** byte is always 0xAA and indicates the beginning of a packet.
- The **flags** bytes form a 16-bit integer representing the packet's payload length and read/write status.
- The **payload** includes the ID byte, the data bytes, and the write bit. Its length is between 1 and 1023 bytes, inclusive depending on the command type.
- The **ID** byte indicates which command the request/response relates to.
- The **command list** is contained later in this product guide.
- The **write** bit is 1 to indicate write mode, or 0 to indicate read mode.
- The **CRC** bytes form a 16-bit/2-byte checksum value used to validate the integrity of the packet data. The sensor will not accept and process a packet if the CRC is not correctly formed. Every byte in the packet except for the CRC itself is included in the checksum calculation.



## 10.2 Checksum algorithm

The **checksum** algorithm is CRC-16-CCITT 0x1021. Below are two CRC calculation examples:

Table 8: Checksum algorithm

C/C++	JavaScript
<pre>uint16_t createCRC(uint8_t* Data, uint16_t Size) {     uint16_t crc = 0;      for (uint32_t i = 0; i &lt; Size; ++i)     {         uint16_t code = crc &gt;&gt; 8;         code ^= Data[i];         code ^= code &gt;&gt; 4;         crc = crc &lt;&lt; 8;         crc ^= code;         code = code &lt;&lt; 5;         crc ^= code;         code = code &lt;&lt; 7;         crc ^= code;     }      return crc; }</pre>	<pre>function createCRC(data, size) {     let crc = 0;      for (let i = 0; i &lt; size; ++i) {         let code = crc &gt;&gt;&gt; 8 &amp; 0xFF;         code ^= data[i] &amp; 0xFF;         code ^= code &gt;&gt;&gt; 4;         crc = crc &lt;&lt; 8 &amp; 0xFFFF;         crc ^= code;         code = code &lt;&lt; 5 &amp; 0xFFFF;         crc ^= code;         code = code &lt;&lt; 7 &amp; 0xFFFF;         crc ^= code;     }      return crc; }</pre>



## 10.3 Reading bytes

Once a packet is successfully read it can be processed based on its command ID. It is vital to **verify the payload length and checksum** before processing.

If either of the following errors are received, “invalid packet length” or “checksum is invalid”, please roll the incoming stream back to one byte after where the start byte was detected.

Below is the process for reading the raw serial byte stream and identifying packets:

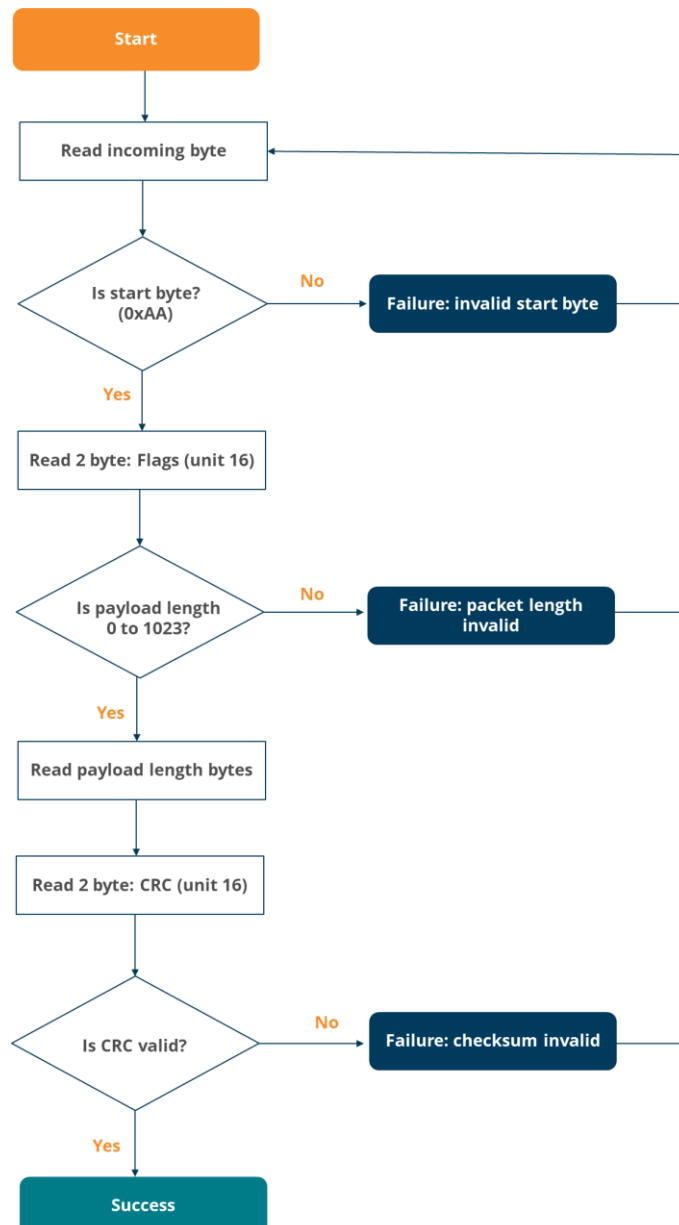

Figure 27: Process flow for reading bytes



## 10.4 Sending commands

Every request sent to the sensor will receive a response. The response also confirms that the request was received and processed. The timeout value and number of retries should be optimized for the specific application.

Below is the process for sending a command request and reading the response:

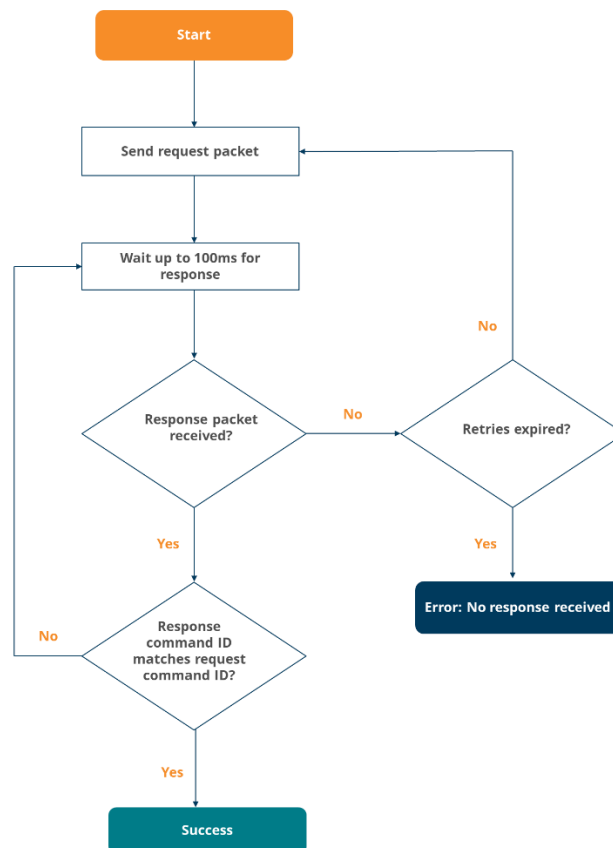

Figure 28: Process flow for sending commands

## 10.5 Saving

Parameters listed in the command list below, and indicated to persist across power cycles, must be saved to onboard flash once changed. To save the parameters, the Token (ID 10) must be read from the unit by sending a read command. The value received must then be sent as the data in the Save Parameters command (ID 12) to the unit.

The Token expires every time after use and consecutive save commands will require the request of a new token prior to the save commands sent.



## 10.6 Command list

Table 9: Command list with descriptions

ID	Name	RW	Read bytes	Write bytes	Persists	Description	
0	Product name	R	16	-	-	A 16-byte string indicating product model name. Always SF000 followed by a null terminator. Use to verify the SF000/B is connected and operational over the selected interface.	
1	Hardware version	R	4/ uint32	-	-	The hardware revision number as a uint32.	
2	Firmware version	R	4	-	-	The currently installed firmware version as 4 bytes. Used to identify the product for API compatibility.	
						1	2
			Patch	Minor	Major	Reserved	
3	Serial number	R	16	-	-	A 16-byte string (null-terminated) of the serial identifier assigned during production.	
9	User data	RW	16	16	Yes	16 bytes of user data stored and read for any purpose.	
10	Token	R	2 /16	-/16	-/Yes	Next usable safety token / Current safety token. Once used, it will expire, and a new token will be created.	
12	Save parameters	W	-	2/ uint16	-	Several commands write to parameters that must be stored and persist across power cycles. This happens when the <i>save parameters</i> command is written with the appropriate safety token. The safety token prevents unintentional writes. The token expires once a successful save has completed.	
14	Reset	W	-	2/ uint16	-	Writing the safety token to this command will restart the sensor.	
27	Distance output	RW	4/ uint32	4/ uint32	No	Configures the (44) <i>distance data</i> command data output. Each bit toggles the output of specified data.	
						Bit	Output
						0	First return raw
						1	First return filter
						2	First return strength
						3	Last return raw
						4	Last return filter
						5	Last return strength
6	Background noise						
7	Temperature						
30	Stream	RW	4/ uint32	4/ uint32	No	<b>Serial and USB interface only.</b> (If used on I <sup>2</sup> C, the data will not be retrievable.) Reading from the stream command will indicate what type of data is currently being streamed. Writing to the stream command will set the type of data to be streamed.	
						Value	Streamed data
						0	disabled
						5	(44) stream distance data cm
6	(45) stream distance data mm						



ID	Name	RW	Read bytes	Write bytes	Persists	Description		
44	Distance data in cm	R	varies	-	-	Distance data in cm as measured by the SF000/B. This command can be read any time, but if (30) stream is set to 5, this command will automatically output at the measurement update rate. The data included will vary and be packed in order based on the configuration of the (27) distance output command.		
						<b>Data output bit</b>	<b>Description</b>	<b>Size</b>
						0	First return raw (cm)	int16
						1	First return filtered (cm)	int16
						2	First return strength (%)	int16
						3	Last return raw (cm)	int16
						4	Last return filtered (cm)	int16
						5	Last return strength (%)	int16
						6	Background noise	int16
7	Temperature (0.01°C)	int16						
45	Distance data in mm	R	varies	-	-	Distance data in mm as measured by the SF000/B. This command can be read any time, but if (30) stream is set to 6, this command will automatically output at the measurement update rate. The data included will vary and be packed in order based on the configuration of the (27) distance output command.		
						<b>Data output bit</b>	<b>Description</b>	<b>Size</b>
						0	First return raw (mm)	int16
						1	First return filtered (mm)	int16
						2	First return strength (%)	int16
						3	Last return raw (mm)	int16
						4	Last return filtered (mm)	int16
						5	Last return strength (%)	int16
						6	Background noise	int16
7	Temperature (0.01°C)	int16						
50	Laser firing	RW	1/ uint8	1/ uint8	No	Reading this command will indicate the current laser firing state. Writing to this command will enable or disable laser firing.		
						<b>Value</b>	<b>Description</b>	
						0	Disabled	
						1	Enabled	
57	Temperature	R	4/ uint32	-	-	Reading this command will return the measured temperature in 0.01 of a degree.		
66	Update rate	RW	1/ uint8	1/ uint8	Yes	Controls the SF000/B's update data sampling update rate. Reading this command will return the current update rate. Writing this command will set the update rate.		
						<b>Command value</b>	<b>Update rate samples/second</b>	
						1	48	
						2	55	
						3	64	
						4	77	
						5	97	
						6	129	
						7	194	
8	388							
74	Noise	R	4/ uint32	-	-	Reading this command will return the level of measured background noise.		



ID	Name	RW	Read bytes	Write bytes	Persists	Description																		
75	Zero offset	RW	4/ int32	4/ int32	Yes	Changing this offset value will change the zero-distance position for the output, written and read in mm.																		
76	Lost signal counter	RW	4/ int32	4/ int32	Yes	Sets the number of lost signal returns before a lost signal indication is output on the distance value. The distance output lost signal indication -1000.																		
79	Baud rate	RW	1/ uint8	1/ uint8	Yes	<p>The serial baud rate used by the serial interface. This parameter only takes effect when the serial interface is first enabled after power-up or restart. Reading this command will return the baud rate. Writing to this command will set the baud rate.</p> <table border="1"> <thead> <tr> <th>Value</th> <th>Baud rate (bps)</th> </tr> </thead> <tbody> <tr><td>0</td><td>9600</td></tr> <tr><td>1</td><td>19200</td></tr> <tr><td>2</td><td>38400</td></tr> <tr><td>3</td><td>57600</td></tr> <tr><td>4</td><td>115200</td></tr> <tr><td>5</td><td>230400</td></tr> <tr><td>6</td><td>460800</td></tr> <tr><td>7</td><td>921600</td></tr> </tbody> </table>	Value	Baud rate (bps)	0	9600	1	19200	2	38400	3	57600	4	115200	5	230400	6	460800	7	921600
Value	Baud rate (bps)																							
0	9600																							
1	19200																							
2	38400																							
3	57600																							
4	115200																							
5	230400																							
6	460800																							
7	921600																							
80	I2C address	RW	1/ uint8	1/ uint8	Yes	<p><b>The I<sup>2</sup>C address value is in decimal.</b> Reading this command will return the I<sup>2</sup>C address. Writing this command will set the I<sup>2</sup>C address.</p>																		
82	Median filter enable	RW	1/ uint8	1/ uint8	Yes	<p>Reading this command will return the status of the median filter. Writing this command will set the status of the median filter.</p> <table border="1"> <thead> <tr> <th>Value</th> <th>Description</th> </tr> </thead> <tbody> <tr><td>0</td><td>Disabled</td></tr> <tr><td>1</td><td>Enabled</td></tr> </tbody> </table>	Value	Description	0	Disabled	1	Enabled												
Value	Description																							
0	Disabled																							
1	Enabled																							
83	Median filter size	RW	4/ int32	4/ int32	Yes	Reading this command will return the size of the median filter. Writing this command will set the size of the median filter. The valid range is 3 to 32.																		
84	Smoothing filter enable	RW	1/ uint8	1/ uint8	Yes	<p>Reading this command will return the status of the smoothing filter. Writing this command will set the status of the smoothing filter.</p> <table border="1"> <thead> <tr> <th>Value</th> <th>Description</th> </tr> </thead> <tbody> <tr><td>0</td><td>Disabled</td></tr> <tr><td>1</td><td>Enabled</td></tr> </tbody> </table>	Value	Description	0	Disabled	1	Enabled												
Value	Description																							
0	Disabled																							
1	Enabled																							
85	Smoothing factor	RW	4/ uint32	4/ uint32	Yes	Reading this command will return the strength of the smoothing filter. Writing this command will set the strength of the smoothing filter. The valid range is 1 to 99.																		
93	Rolling average enable	RW	1/ uint8	1/ uint8	Yes	<p>Reading this command will return the status of the rolling average filter. Writing this command will set the status of the rolling average filter.</p> <table border="1"> <thead> <tr> <th>Value</th> <th>Description</th> </tr> </thead> <tbody> <tr><td>0</td><td>Disabled</td></tr> <tr><td>1</td><td>Enabled</td></tr> </tbody> </table>	Value	Description	0	Disabled	1	Enabled												
Value	Description																							
0	Disabled																							
1	Enabled																							
94	Rolling average size	RW	4/ uint32	4/ uint32	Yes	Reading this command will return the size of the rolling average filter. Writing this command will set the size of the rolling average filter. The valid range is 2 to 32.																		



## 11 Firmware updates

Occasionally, LightWare will release new firmware for your sensor, to address bug fixes or introduce additional features. All registered customers will receive an email notification when new firmware is released for their LightWare sensor.

**Caution: LightWare strongly advises that all LightWare sensors are kept up to date with their latest firmware revision.**

You can check whether your sensor is equipped with the latest firmware and access updates directly through LightWare Studio as follows:

1. Select *Upgrade* from the left panel.

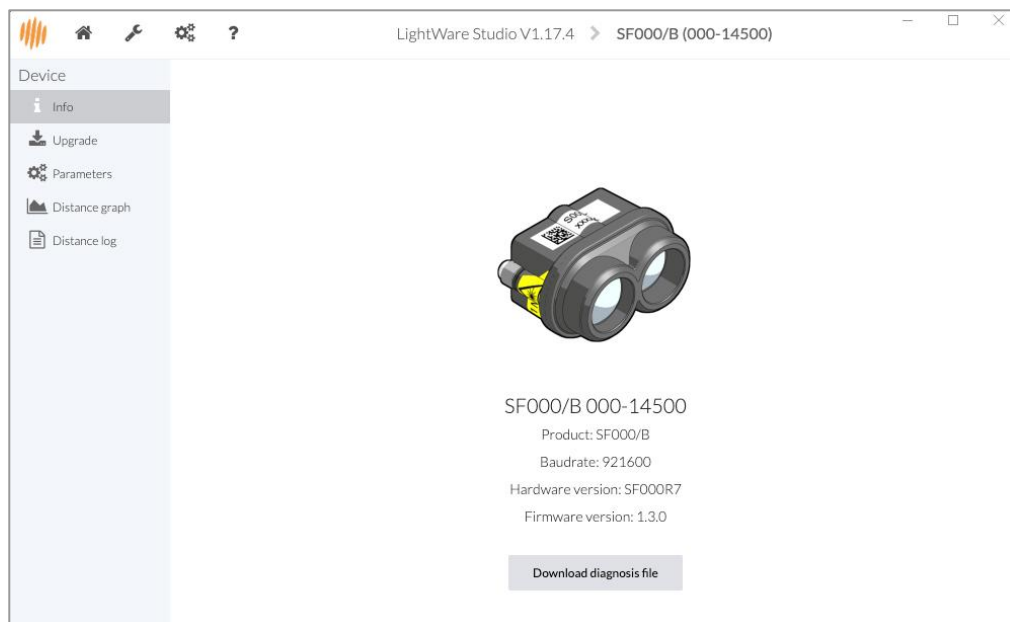

Figure 29: LightWare Studio device information page

2. The page will display the firmware version currently installed on the sensor and indicate whether any recent upgrades are available for download.
3. If you need to upgrade, click the *Install* button, and follow the instructions.

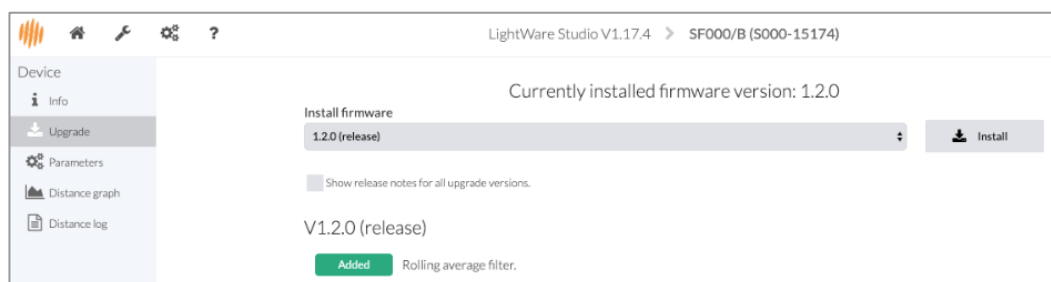

Figure 30: LightWare Studio firmware upgrade page



## 12 Troubleshooting

Table 10: SF000/B Troubleshooting

Problem	Solution
1. Sensor outputs a short distance reading or distorted distance reading	<ul style="list-style-type: none"> <li>The sensor is receiving a signal caused by scattered light from a close-by object in the vicinity of the beam, such as a desk surface, landing gear, pole, or highly reflective object. Relocate your sensor or the object and test again.</li> </ul>
2. Sensor outputs -1/ 230	<ul style="list-style-type: none"> <li>This is an out-of-range condition. There is no measurable object within the sensor's range.</li> </ul>
3. Sensor is not communicating with the serial UART controller at all.	<ul style="list-style-type: none"> <li>Ensure that the sensor's baud rate is compatible with the controller.</li> <li>Ensure that the sensor's TXD and RXD lines are connected to the controller's RXD and TXD lines, respectively.</li> <li>If using ArduPilot or PX4, ensure that the correct parameters for sensor integration have been set.</li> <li>Ensure that the sensor supply voltage is within the specified range and is not dropping below the specified minimum level.</li> <li>If using a separate power supply, ensure a common ground.</li> </ul>
4. Sensor is not communicating with the I <sup>2</sup> C controller at all.	<ul style="list-style-type: none"> <li>Ensure Pin 2 and Pin 4 are being used together as the SDA line.</li> <li>Ensure that the sensor SDA and SCL lines are connected to the controller SDA and SCL lines, respectively.</li> <li>If using ArduPilot or PX4, ensure that the correct parameters for sensor integration have been set.</li> <li>Ensure that the sensor supply voltage is within the specified range and is not dropping below the specified minimum level.</li> <li>If using a separate power supply, ensure a common ground.</li> </ul>
5. Sensor stops communicating during flight	<ul style="list-style-type: none"> <li>Check the power supply to the sensor.</li> <li>Ensure all cable connections are properly seated and secured.</li> </ul>
6. Readings are erratic or changing too fast	<ul style="list-style-type: none"> <li>Check the update rate and ensure it is suitable for the application. (Slower update rates are advised for altimetry.)</li> <li>Consider using the built-in filters to remove background noise.</li> <li>Investigate possible sources of electromagnetic interference (EMI).</li> </ul>
7. The sensor is running hot	<ul style="list-style-type: none"> <li>Ensure adequate ventilation and heat sinking to prevent heat build-up.</li> </ul>
8. Sensor not working via Serial adapter	<ul style="list-style-type: none"> <li>If the sensor was set to startup in I<sup>2</sup>C mode, please contact our technical support team for assistance.</li> <li>The maximum baud rate supported by the LightWare USB adaptor is 921600. If the baud rate was set to a value higher than 921600, please contact our technical support team for assistance.</li> </ul>



For issues not covered above, refer to the FAQs in the LightWare website resource center or contact LightWare's dedicated technical support team for assistance with remote testing of your LightWare microLiDAR® sensor.

## 13 Repair and maintenance

### 13.1 Maintenance and calibration

The LightWare microLiDAR® sensor contains no moving parts, and **no regular maintenance** is required. The sensor **does not need regular calibration** and will remain true to specification throughout its lifespan if used as directed.

### 13.2 Cleaning

The lenses of the LightWare microLiDAR® are coated with an anti-reflective, non-scratch coating. If lenses collect dust, use a clean, soft cloth or air compressor to remove it. Should that not be sufficient to clean the lenses, only isopropyl alcohol should be used to avoid scratching the sensor's lens or damaging the coating. Keep the device free from moisture in accordance with its IP rating.

### 13.3 Electrical safety

- Check all electrical connections are isolated and that there are no exposed wires.
- Ensure the power supplied to the device does not exceed the maximum rated voltages specified in the technical specifications section.
- Keep the device free from moisture in accordance with the IP rating.



## 13.4 Service and repairs

If you experience any problems with your sensor, please contact the LightWare technical support desk for in-field diagnostics before sending the unit to LightWare. During in-field support, you may be requested to supply the device's diagnostics file, which can be downloaded from LightWare Studio from the device *info* page.

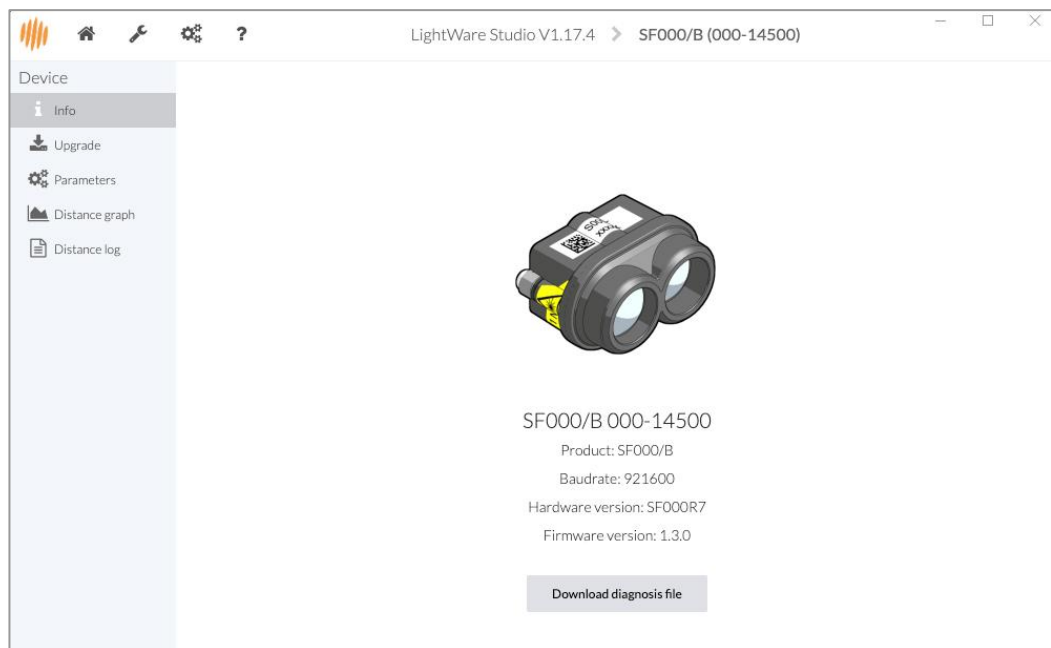

Figure 31: LightWare Studio device information page

If the unit needs to be returned to LightWare for repairs, LightWare support will assist you with the Return Merchandise Authorization (RMA) procedure.



## 14 End-of-life safe disposal

At LightWare, we are committed to protecting the environment and ensuring that our products have minimal impact on the planet at the end of their lifecycle. As your device reaches the end of its operational life, we encourage you to dispose of it in a responsible and environmentally friendly manner.

Please do not dispose of LightWare sensors with general household or commercial waste.

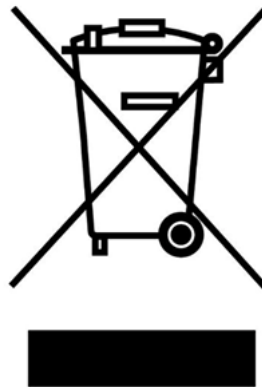

Figure 32: End-of-life disposal

LightWare sensors consist of ABS and other plastics, acrylic, and glass components, which are widely recyclable. The electronic PC board assembly should be disposed of through a reputable electronic waste recycler in your area. Alternatively, return your device to LightWare for safe disposal.



## 15 Document revision history

Table 11: Revision history

Revision	Date	Comments
Rev 7.3	2026/05/04	Wider operating temperature specifications published (-20°C to 60°C)
Rev 7.2	2025/11/24	Changed Pixhawk adapter and mounting bracket to optional accessories.
Rev 7.1	2025/06/11	Added use of isopropyl alcohol as required lens cleaning solution & DroneCAN Adapter
Rev 7	2025/01/07	Minor style and text updates. Single communications cable included.
Rev 6	2024/09/20	Review entire manual and move to new standard product guide template. Check and update product information and LightWare Studio interface. Review specifications entirely. Correct eye safety data to refer to non-ionizing radiation.
Rev 5	2022/02/15	PDF format of guide release
Rev 4	2022/01/12	Introduction of online guide format
Rev 3	2021/06/17	Typo on page 1 and 3 constraint to constrained
Rev 2	2021/02/17	Breakout board section has been inserted
Rev 1	2020/11/18	FDA accession number added, notification that I <sup>2</sup> C pins 2 and 4 need to be used as for SDA
Rev 0	2020/08/03	First edition

